

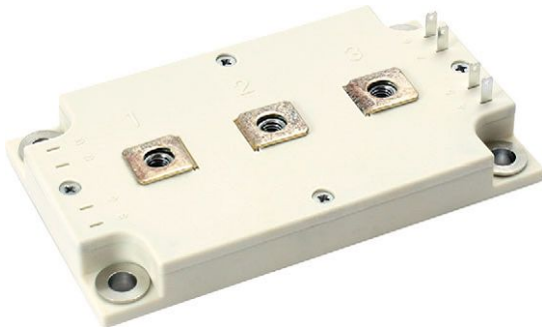



# Dual INT-A-PAK Low Profile “Half Bridge” (Trench PT IGBT), 300 A

Proprietary Vishay IGBT Silicon “L Series”



Dual INT-A-PAK Low Profile

### FEATURES

- Trench PT IGBT technology
- Low  $V_{CE(on)}$
- Square RBSOA
- HEXFRED® antiparallel diode with ultrasoft reverse recovery characteristics
- Industry standard package
- $Al_2O_3$  DBC
- UL approved file E78996 
- Designed for industrial level
- Material categorization: for definitions of compliance please see [www.vishay.com/doc?99912](http://www.vishay.com/doc?99912)



RoHS COMPLIANT

PRIMARY CHARACTERISTICS	
$V_{CES}$	600 V
$I_C$ DC at $T_C = 104\text{ °C}$	300 A
$V_{CE(on)}$ (typical) at 300 A, 25 °C	1.30 V
Speed	DC to 1 kHz
Package	Dual INT-A-PAK low profile
Circuit configuration	Half bridge

### BENEFITS

- Increased operating efficiency
- Performance optimized as output inverter stage for TIG welding machines
- Direct mounting on heatsink
- Very low junction to case thermal resistance

ABSOLUTE MAXIMUM RATINGS				
PARAMETER	SYMBOL	TEST CONDITIONS	MAX.	UNITS
Collector to emitter voltage	$V_{CES}$		600	V
Continuous collector current	$I_C$ <sup>(1)</sup>	$T_C = 25\text{ °C}$	580	A
		$T_C = 80\text{ °C}$	400	
Pulsed collector current	$I_{CM}$		800	
Clamped inductive load current	$I_{LM}$		800	
Diode continuous forward current	$I_F$	$T_C = 25\text{ °C}$	219	
		$T_C = 80\text{ °C}$	145	
Gate to emitter voltage	$V_{GE}$		$\pm 20$	V
Maximum power dissipation (IGBT)	$P_D$	$T_C = 25\text{ °C}$	1136	W
		$T_C = 80\text{ °C}$	636	
RMS isolation voltage	$V_{ISOL}$	Any terminal to case ( $V_{RMS} t = 1\text{ s}$ , $T_J = 25\text{ °C}$ )	3500	V
Operating junction and storage temperature range	$T_J, T_{Stg}$		-40 to +150	°C

### Note

<sup>(1)</sup> Maximum continuous collector current must be limited to 500 A to do not exceed the maximum temperature of terminals



<b>ELECTRICAL SPECIFICATIONS</b> ( $T_J = 25\text{ }^\circ\text{C}$ unless otherwise specified)						
PARAMETER	SYMBOL	TEST CONDITIONS	MIN.	TYP.	MAX.	UNITS
Collector to emitter breakdown voltage	$V_{BR(CE)}$	$V_{GE} = 0\text{ V}, I_C = 500\text{ }\mu\text{A}$	600	-	-	V
Collector to emitter voltage	$V_{CE(on)}$	$V_{GE} = 15\text{ V}, I_C = 150\text{ A}$	-	1.12	1.21	
		$V_{GE} = 15\text{ V}, I_C = 300\text{ A}$	-	1.30	1.45	
		$V_{GE} = 15\text{ V}, I_C = 150\text{ A}, T_J = 125\text{ }^\circ\text{C}$	-	1.03	-	
		$V_{GE} = 15\text{ V}, I_C = 300\text{ A}, T_J = 125\text{ }^\circ\text{C}$	-	1.26	-	
Gate threshold voltage	$V_{GE(th)}$	$V_{CE} = V_{GE}, I_C = 6.4\text{ mA}$	4.9	6.0	8.8	
		$V_{CE} = V_{GE}, I_C = 6.4\text{ mA}, T_J = 125\text{ }^\circ\text{C}$	-	3.4	-	
Temperature coefficient of threshold voltage	$\Delta V_{GE(th)}/\Delta T$	$V_{CE} = V_{GE}, I_C = 6.4\text{ mA}, (25\text{ }^\circ\text{C to } 125\text{ }^\circ\text{C})$	-	-26	-	mV/°C
Forward transconductance	$g_{fe}$	$V_{CE} = 20\text{ V}, I_C = 50\text{ A}$	-	67	-	S
Transfer characteristics	$V_{GE}$	$V_{CE} = 20\text{ V}, I_C = 300\text{ A}$	-	11.4	-	V
Collector to emitter leakage current	$I_{CES}$	$V_{GE} = 0\text{ V}, V_{CE} = 600\text{ V}$	-	4.0	150	$\mu\text{A}$
		$V_{GE} = 0\text{ V}, V_{CE} = 600\text{ V}, T_J = 125\text{ }^\circ\text{C}$	-	100	-	
Diode forward voltage drop	$V_{FM}$	$I_{FM} = 150\text{ A}$	-	1.31	1.41	V
		$I_{FM} = 300\text{ A}$	-	1.56	1.75	
		$I_{FM} = 150\text{ A}, T_J = 125\text{ }^\circ\text{C}$	-	1.28	-	
		$I_{FM} = 300\text{ A}, T_J = 125\text{ }^\circ\text{C}$	-	1.63	-	
Gate to emitter leakage current	$I_{GES}$	$V_{GE} = \pm 20\text{ V}$	-	-	$\pm 500$	nA

<b>SWITCHING CHARACTERISTICS</b> ( $T_J = 25\text{ }^\circ\text{C}$ unless otherwise specified)						
PARAMETER	SYMBOL	TEST CONDITIONS	MIN.	TYP.	MAX.	UNITS
Turn-on switching energy	$E_{on}$	$I_C = 300\text{ A}, V_{CC} = 300\text{ V}, V_{GE} = 15\text{ V}, R_g = 1.5\text{ }\Omega, L = 500\text{ }\mu\text{H}, T_J = 25\text{ }^\circ\text{C}$	-	6.0	-	mJ
Turn-off switching energy	$E_{off}$		-	33	-	
Total switching energy	$E_{tot}$		-	39	-	
Turn-on delay time	$t_{d(on)}$	$I_C = 300\text{ A}, V_{CC} = 300\text{ V}, V_{GE} = 15\text{ V}, R_g = 1.5\text{ }\Omega, L = 500\text{ }\mu\text{H}, T_J = 125\text{ }^\circ\text{C}$	-	503	-	ns
Rise time	$t_r$		-	214	-	
Turn-off delay time	$t_{d(off)}$		-	600	-	
Fall time	$t_f$		-	547	-	
Turn-on switching loss	$E_{on}$		-	7.2	-	
Turn-off switching loss	$E_{off}$	-	55.2	-		
Total switching loss	$E_{tot}$	-	62.4	-		
Turn-on delay time	$t_{d(on)}$	$I_C = 300\text{ A}, V_{CC} = 300\text{ V}, V_{GE} = 15\text{ V}, R_g = 1.5\text{ }\Omega, L = 500\text{ }\mu\text{H}, T_J = 125\text{ }^\circ\text{C}$	-	476	-	ns
Rise time	$t_r$		-	209	-	
Turn-off delay time	$t_{d(off)}$		-	807	-	
Fall time	$t_f$		-	918	-	
Reverse bias safe operating area	RBSOA	$T_J = 150\text{ }^\circ\text{C}, I_C = 800\text{ A}, V_{CC} = 300\text{ V}, V_P = 600\text{ V}, R_g = 1.5\text{ }\Omega, V_{GE} = 15\text{ V to } 0\text{ V}, L = 500\text{ }\mu\text{H}$	Fullsquare			
Diode reverse recovery time	$t_{rr}$	$I_F = 300\text{ A}, R_g = 1.5\text{ }\Omega, V_{CC} = 300\text{ V}, T_J = 25\text{ }^\circ\text{C}$	-	119	-	ns
Diode peak reverse current	$I_{rr}$		-	99	-	A
Diode recovery charge	$Q_{rr}$		-	7.3	-	$\mu\text{C}$
Diode reverse recovery time	$t_{rr}$	$I_F = 300\text{ A}, R_g = 1.5\text{ }\Omega, V_{CC} = 300\text{ V}, T_J = 125\text{ }^\circ\text{C}$	-	165	-	ns
Diode peak reverse current	$I_{rr}$		-	127	-	A
Diode recovery charge	$Q_{rr}$		-	13	-	$\mu\text{C}$



THERMAL AND MECHANICAL SPECIFICATIONS					
PARAMETER	SYMBOL	MIN.	TYP.	MAX.	UNITS
Operating junction and storage temperature range	$T_J, T_{Stg}$	-40	-	150	°C
Junction to case per leg	IGBT	-	-	0.11	°C/W
	diode	-	-	0.4	
Case to sink per module	$R_{thCS}$	-	0.05	-	
Mounting torque	case to heatsink: M6 screw	4	-	6	Nm
	case to terminal 1, 2, 3: M5 screw	2	-	5	
Weight		-	270	-	g

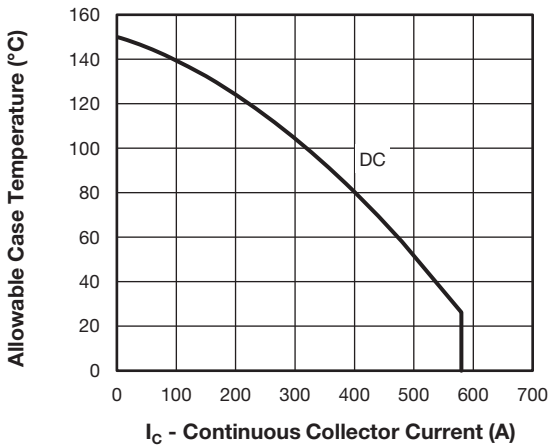

Fig. 1 - Maximum IGBT Continuous Collector Current vs. Case Temperature

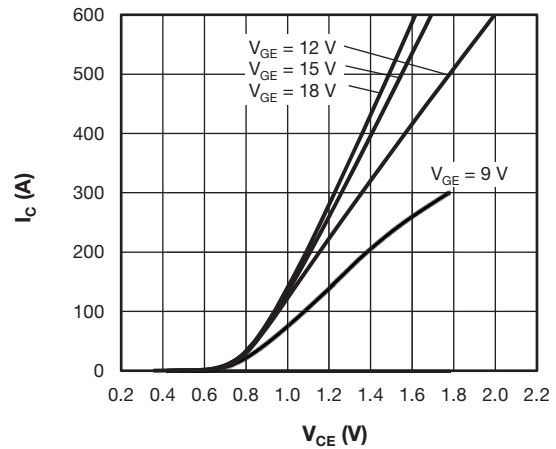

Fig. 3 - Typical IGBT Output Characteristics,  $T_J = 125$  °C

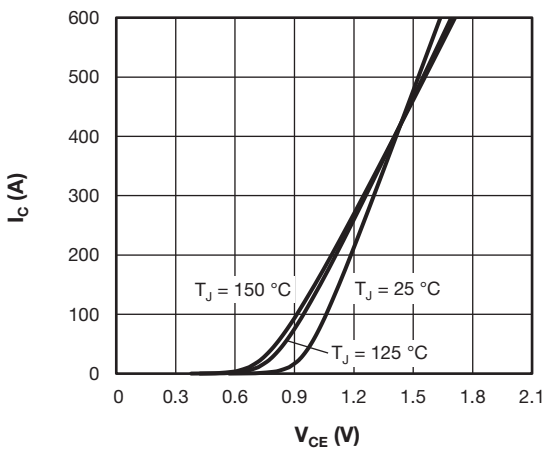

Fig. 2 - Typical IGBT Output Characteristics,  $V_{GE} = 15$  V

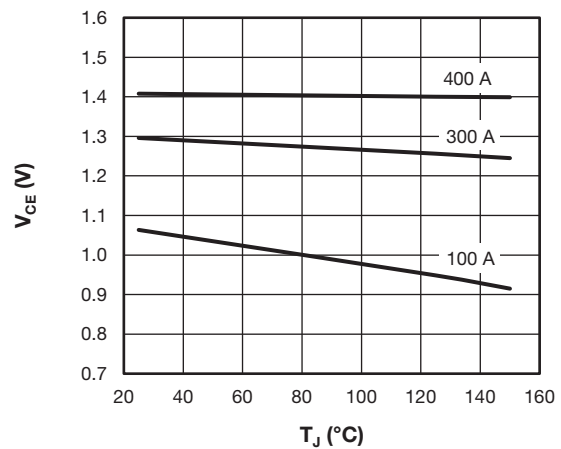

Fig. 4 - Collector to Emitter Voltage vs. Junction Temperature

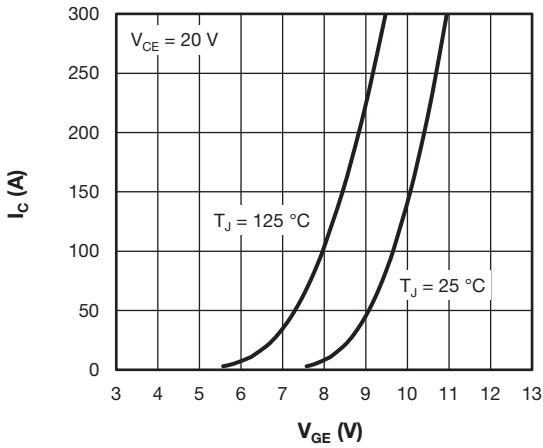

Fig. 5 - Typical IGBT Transfer Characteristics

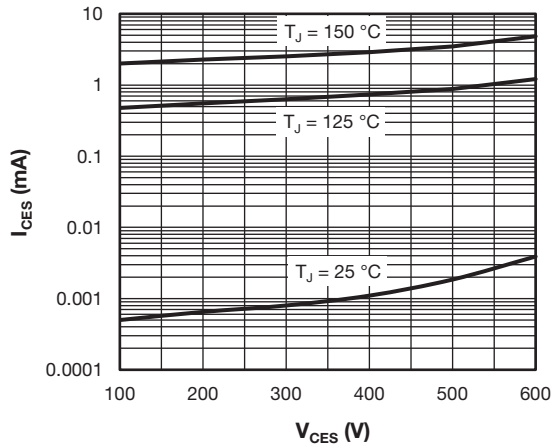

Fig. 8 - Typical IGBT Zero Gate Voltage Collector Current

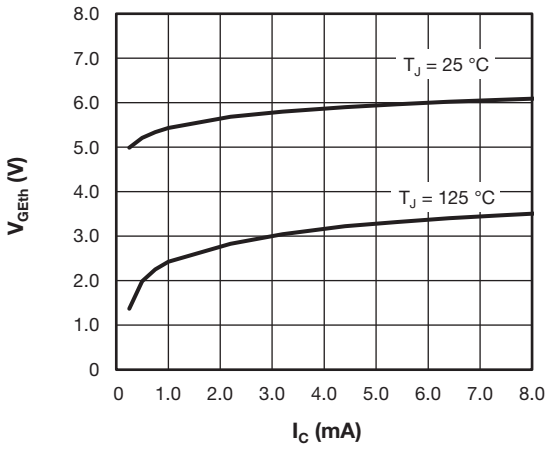

Fig. 6 - Typical IGBT Gate Threshold Voltage

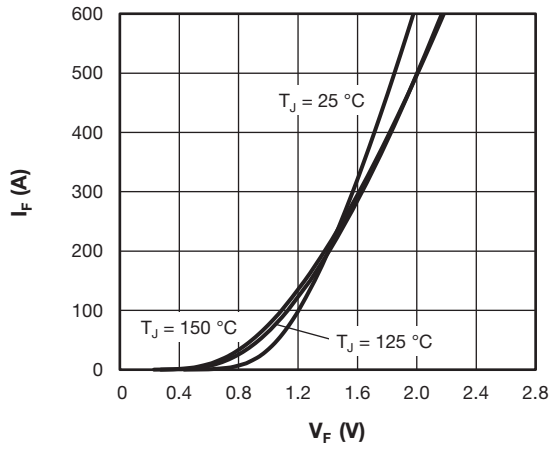

Fig. 9 - Typical Diode Forward Characteristics

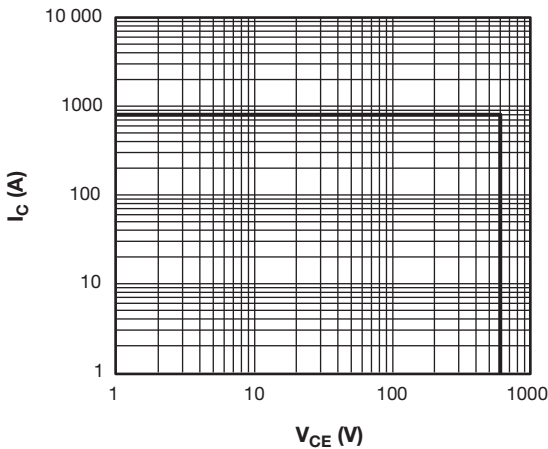

Fig. 7 - IGBT Reverse BIAS SOA  $T_J = 150^\circ\text{C}$ ,  $V_{GE} = 15\text{V}$

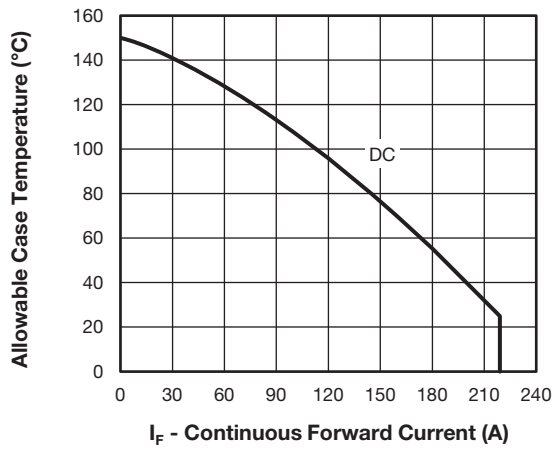

Fig. 10 - Maximum Diode Continuous Forward Current vs. Case Temperature

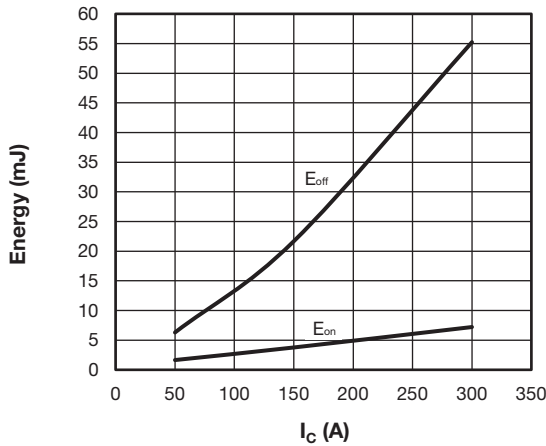

Fig. 11 - Typical IGBT Energy Loss vs.  $I_C$   
 $T_J = 125\text{ }^\circ\text{C}$ ,  $V_{CC} = 300\text{ V}$ ,  $R_g = 1.5\ \Omega$ ,  $V_{GE} = 15\text{ V}$ ,  $L = 500\ \mu\text{H}$

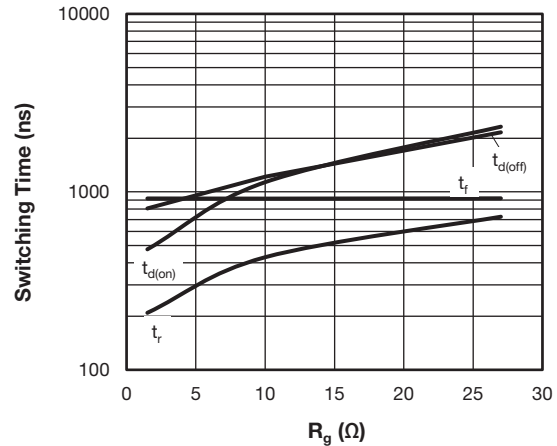

Fig. 14 - Typical IGBT Switching Time vs.  $R_g$   
 $T_J = 125\text{ }^\circ\text{C}$ ,  $V_{CC} = 300\text{ V}$ ,  $I_C = 300\text{ A}$ ,  $V_{GE} = 15\text{ V}$ ,  $L = 500\ \mu\text{H}$

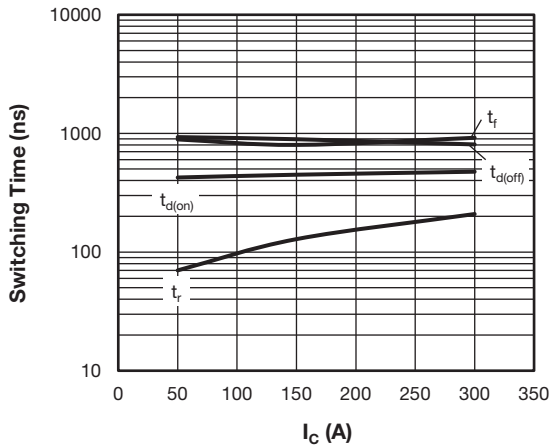

Fig. 12 - Typical IGBT Switching Time vs.  $I_C$   
 $T_J = 125\text{ }^\circ\text{C}$ ,  $V_{CC} = 300\text{ V}$ ,  $R_g = 1.5\ \Omega$ ,  $V_{GE} = 15\text{ V}$ ,  $L = 500\ \mu\text{H}$

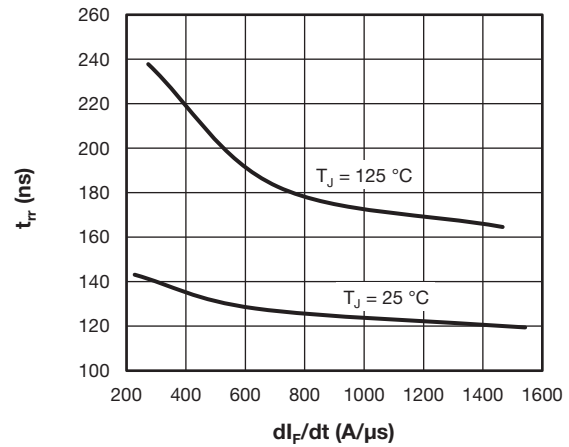

Fig. 15 - Typical Diode Reverse Recovery Time vs.  $dI_F/dt$   
 $V_{CC} = 300\text{ V}$ ,  $I_F = 300\text{ A}$

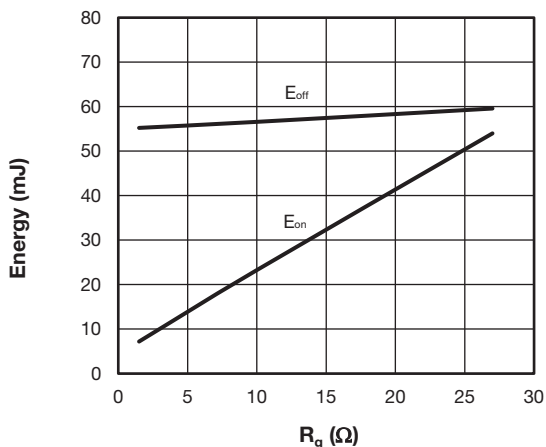

Fig. 13 - Typical IGBT Energy Loss vs.  $R_g$   
 $T_J = 125\text{ }^\circ\text{C}$ ,  $V_{CC} = 300\text{ V}$ ,  $I_C = 300\text{ A}$ ,  $V_{GE} = 15\text{ V}$ ,  $L = 500\ \mu\text{H}$

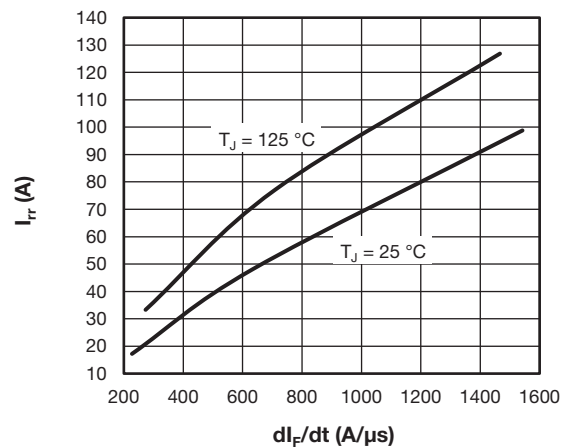

Fig. 16 - Typical Diode Reverse Recovery Current vs.  $dI_F/dt$   
 $V_{CC} = 300\text{ V}$ ,  $I_F = 300\text{ A}$

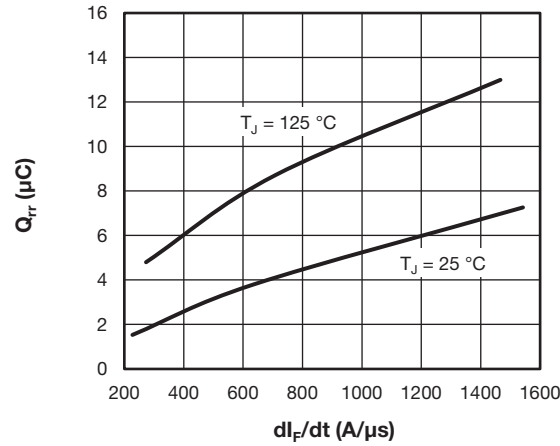

Fig. 17 - Typical Diode Reverse Recovery Charge vs.  $di_F/dt$   
 $V_{CC} = 300\text{ V}$ ,  $I_F = 300\text{ A}$

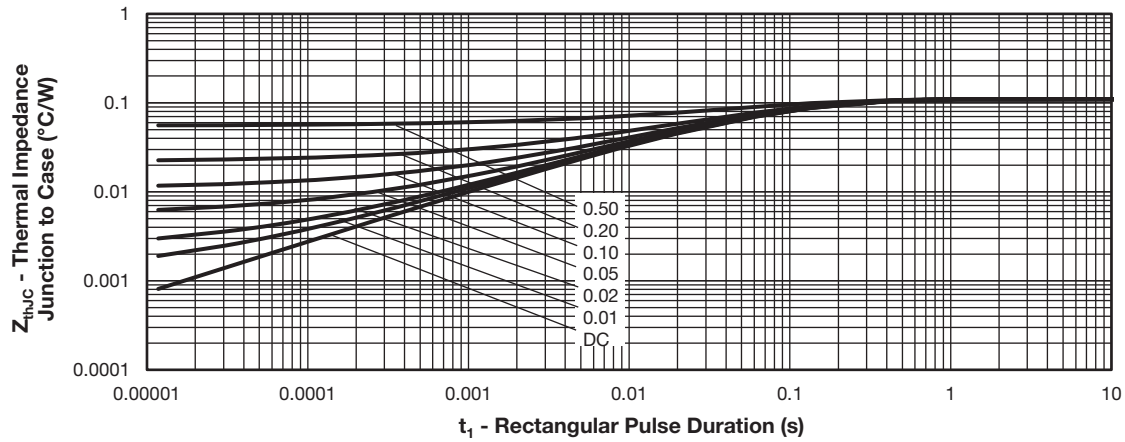

Fig. 18 - Maximum Thermal Impedance  $Z_{thJC}$  Characteristics - (IGBT)

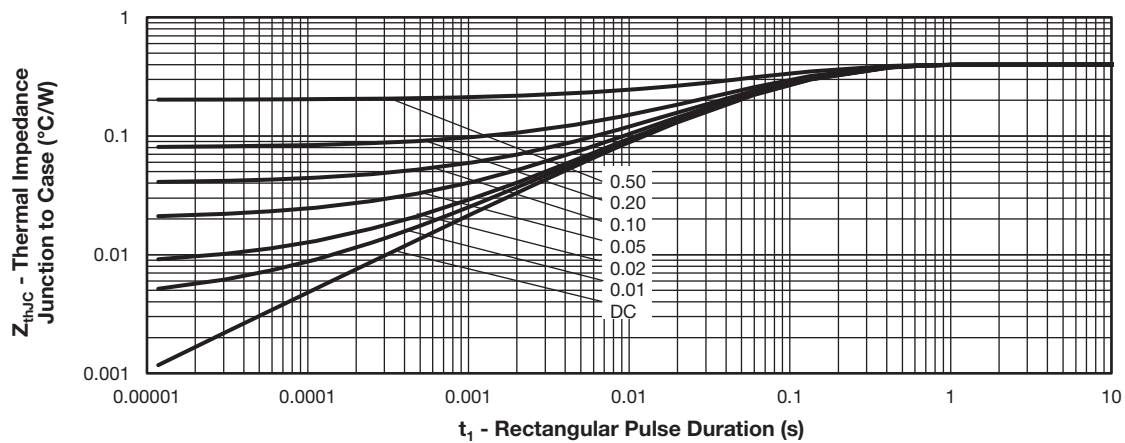

Fig. 19 - Maximum Thermal Impedance  $Z_{thJC}$  Characteristics - (Diode)

## ORDERING INFORMATION TABLE

Device code	<b>VS-</b>	<b>G</b>	<b>P</b>	<b>300</b>	<b>T</b>	<b>D</b>	<b>60</b>	<b>S</b>
	①	②	③	④	⑤	⑥	⑦	⑧

- 1** - Vishay Semiconductors product
- 2** - Insulated gate bipolar transistor (IGBT)
- 3** - Trench PT IGBT technology
- 4** - Current rating (300 = 300 A)
- 5** - Circuit configuration (T = half bridge)
- 6** - Package indicator (D = dual INT-A-PAK low profile)
- 7** - Voltage rating (60 = 600 V)
- 8** - Speed / type (S = standard speed IGBT)

## CIRCUIT CONFIGURATION

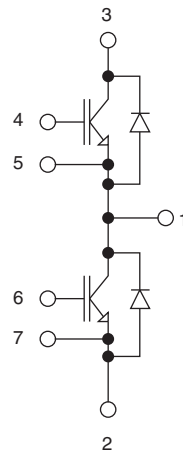

### LINKS TO RELATED DOCUMENTS

Dimensions	<a href="http://www.vishay.com/doc?95435">www.vishay.com/doc?95435</a>
------------	------------------------------------------------------------------------



## Dual INT-A-PAK Low Profile

**DIMENSIONS** in millimeters

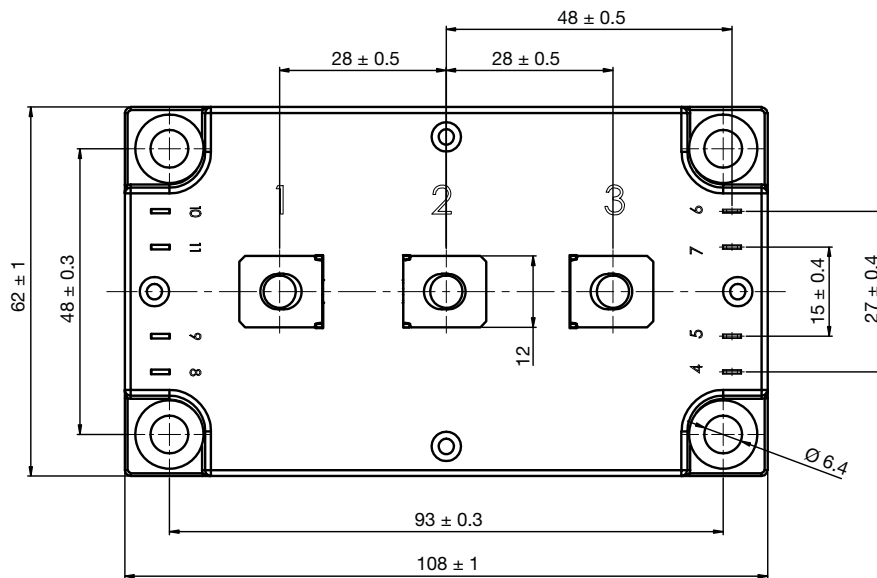
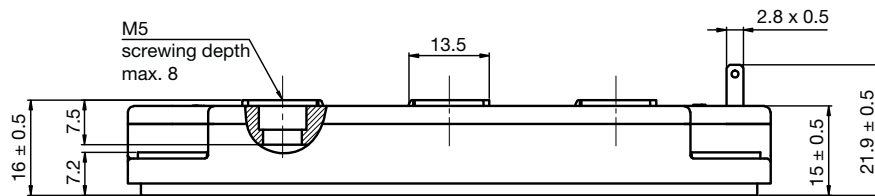





## Disclaimer

ALL PRODUCT, PRODUCT SPECIFICATIONS AND DATA ARE SUBJECT TO CHANGE WITHOUT NOTICE TO IMPROVE RELIABILITY, FUNCTION OR DESIGN OR OTHERWISE.

Vishay Intertechnology, Inc., its affiliates, agents, and employees, and all persons acting on its or their behalf (collectively, "Vishay"), disclaim any and all liability for any errors, inaccuracies or incompleteness contained in any datasheet or in any other disclosure relating to any product.

Vishay makes no warranty, representation or guarantee regarding the suitability of the products for any particular purpose or the continuing production of any product. To the maximum extent permitted by applicable law, Vishay disclaims (i) any and all liability arising out of the application or use of any product, (ii) any and all liability, including without limitation special, consequential or incidental damages, and (iii) any and all implied warranties, including warranties of fitness for particular purpose, non-infringement and merchantability.

Statements regarding the suitability of products for certain types of applications are based on Vishay's knowledge of typical requirements that are often placed on Vishay products in generic applications. Such statements are not binding statements about the suitability of products for a particular application. It is the customer's responsibility to validate that a particular product with the properties described in the product specification is suitable for use in a particular application. Parameters provided in datasheets and / or specifications may vary in different applications and performance may vary over time. All operating parameters, including typical parameters, must be validated for each customer application by the customer's technical experts. Product specifications do not expand or otherwise modify Vishay's terms and conditions of purchase, including but not limited to the warranty expressed therein.

Hyperlinks included in this datasheet may direct users to third-party websites. These links are provided as a convenience and for informational purposes only. Inclusion of these hyperlinks does not constitute an endorsement or an approval by Vishay of any of the products, services or opinions of the corporation, organization or individual associated with the third-party website. Vishay disclaims any and all liability and bears no responsibility for the accuracy, legality or content of the third-party website or for that of subsequent links.

Except as expressly indicated in writing, Vishay products are not designed for use in medical, life-saving, or life-sustaining applications or for any other application in which the failure of the Vishay product could result in personal injury or death. Customers using or selling Vishay products not expressly indicated for use in such applications do so at their own risk. Please contact authorized Vishay personnel to obtain written terms and conditions regarding products designed for such applications.

No license, express or implied, by estoppel or otherwise, to any intellectual property rights is granted by this document or by any conduct of Vishay. Product names and markings noted herein may be trademarks of their respective owners.